

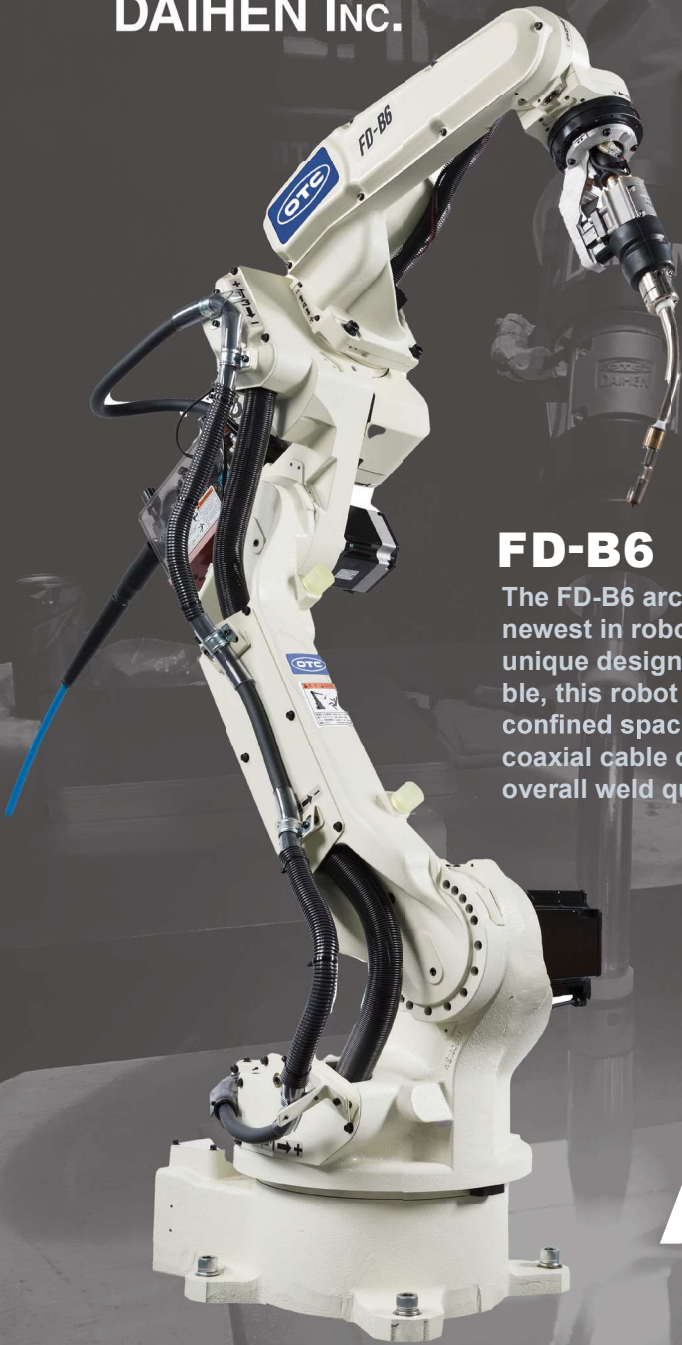

DAIHEN INC.

**FD** *Friendly series*



### **FD-B6**

The FD-B6 arc welding robot represents the newest in robotic innovations. Sporting a unique design with a through-arm coaxial cable, this robot is highly versatile at welding in confined spaces and complicated fixtures. The coaxial cable of the FD-B6 also helps improve overall weld quality.

**COMPLETE  
ROBOTIC  
ARC WELDING  
SYSTEMS**

[WWW.DAIHEN-USA.COM](http://WWW.DAIHEN-USA.COM)

# THE IDEAL SOLUTION FOR AUTOMATION OF WELDING

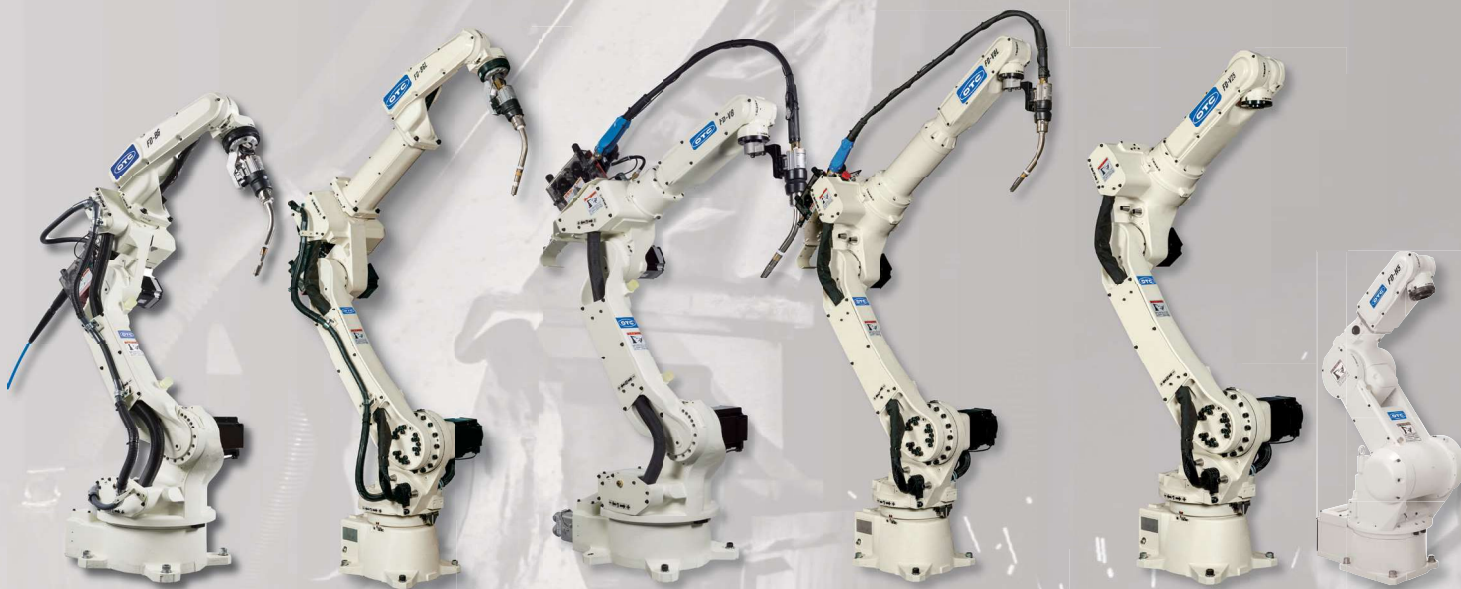

**FD-B6 FD-B6L-S2 FD-V8 FD-V8L-S2 FD-V25-S2 FD-H5**

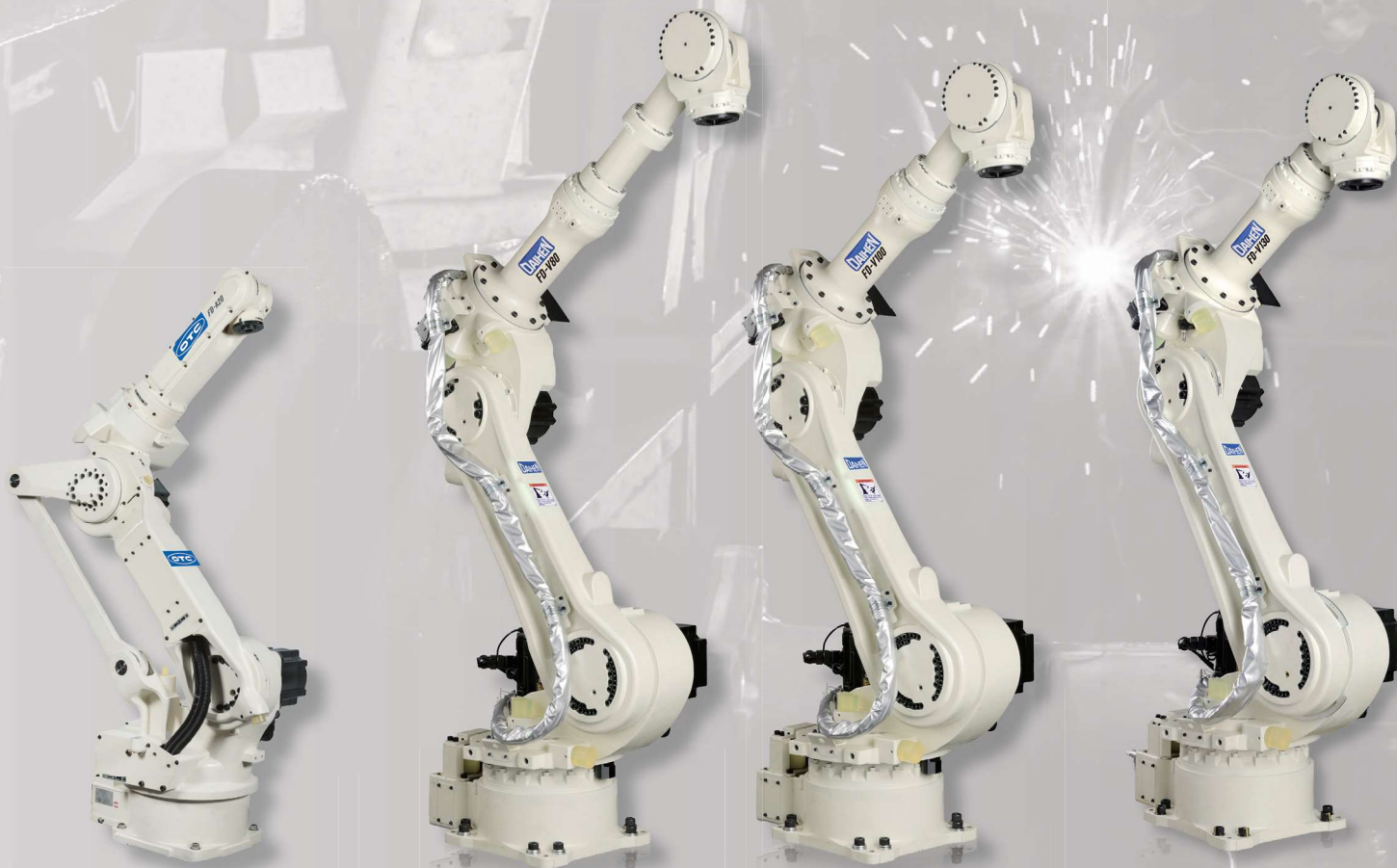

**FD-A20**

**FD-V80**

**FD-V100**

**FD-V130**

# CHANGING THE FUTURE OF MANUFACTURING

## OPTIMUM TEACHING

Easy teaching, even for a two-electrode torch



**FD-B4S**

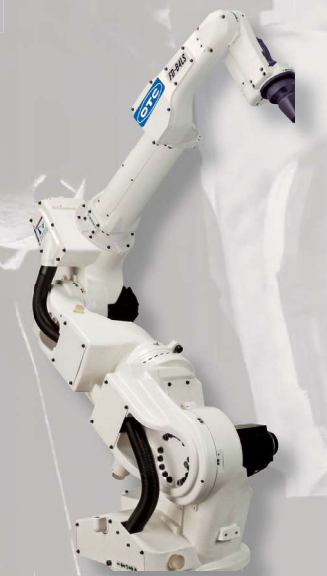

**FD-B4LS**



**FD-V6S**



**FD-V6LS**



**FD-V20S**

Our arc welding robots are ideal for many welding and air plasma cutting applications.

They can be used for mild steel, stainless steel, aluminum, titanium and other exotic metals.

While some models feature a compact design, robots can handle a variety of jobs ranging from small to large in size.

All robots include a FD21 robot controller and a teach pendant.

## **FD** *Friendly series*



**EASY**

### **Intuitive Operation**

Touch panel and jog dial ensure easy operation.



**QUALITY**

### **Quality Control Functions**

Easy quantitative management of welding procedures.



**ECOLOGY**

### **Compact and Eco-Friendly**

Space-saving design with reduced standby power consumption.



## SMOOTH OPERATION TEACH PENDANT

## SMART CONTROLLER FD21

### FD21 TEACH PENDANT

#### Redesigned for comfortable, extended use

- 66% less arm fatigue
- Weight reduced by 15%
- Grip redesigned with comfortable 3D contouring
- Easy-to-press keypad with lighter press force
- Keypad delivers tactile <click> feedback
- Raised features on keypad for tactile, “no-look” navigation
- Added two (2) quick-keys for HOME SCREEN and MENU for faster navigation
- Redesigned for reliability
- Weld-spatter-resistant border around touch-screen
- Pluggable teach pendant cable for rapid damaged cable replacement
- Hanger hook is now a replaceable, wear item
- Touch-screen upgraded
- Improved resolution and contrast
- Faster response
- Finer touch resolution
- Supports touch-screen only program editing
- Scroll with swiping action
- On-screen keypad for numeric entry
- Menu icons for tablet/phone-like operation



### FD21 ROBOT CONTROLLER

#### Versatility to “Connect” with facilities, devices and users.

- Easily “CONNECTS” with peripheral equipment through simplified system configuration
- “CONNECTS” from anywhere in the world
- Expanded motion control via “connectable” external axis unit
- Improved “Connectivity” for multiple robots and multiple auxiliary axes
- Enhance your system by “connecting” commercial peripherals
- Offline teaching “CONNECTS” you to uninterrupted production



# RANGE OF MOTION MANIPULATOR WORKING RANGE / SPECIFICATIONS

## FD-B6 Standard

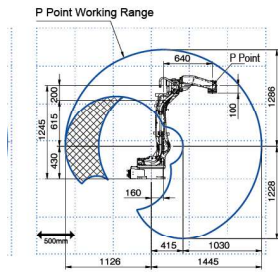

Reach	1445mm
Payload	6kg
Axes	6
Repeatability	± 0.08mm

## FD-V8 Standard

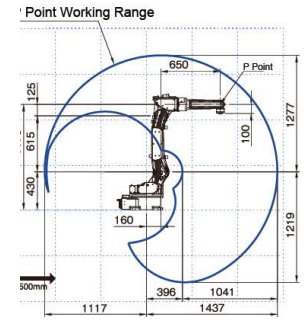

Reach	1402mm
Payload	8kg
Axes	6
Repeatability	± 0.08mm

## FD-B6L-S2 Long Reach

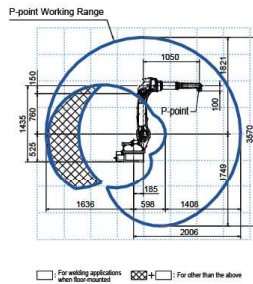

Reach	2008mm
Payload	6kg
Axes	6
Repeatability	± 0.08mm

## FD-V8L-S2 Long Reach

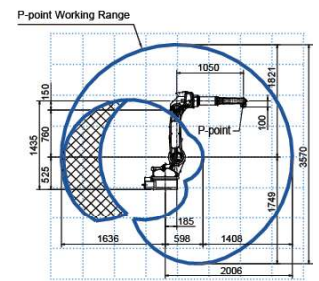

Reach	2006mm
Payload	8kg
Axes	6
Repeatability	± 0.08mm

## FD-V25-S2 Standard

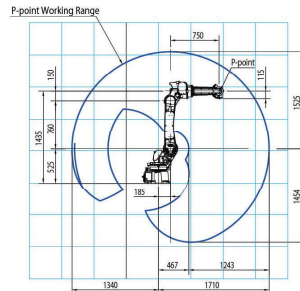

Reach	1710mm
Payload	25kg
Axes	6
Repeatability	± 0.08mm

## FD-H5 Compact

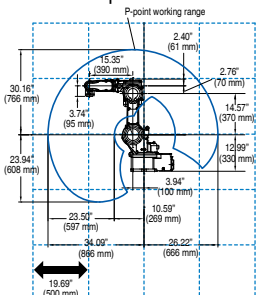

Reach	866mm
Payload	5kg
Axes	6
Repeatability	± 0.08mm



### FD-B4S

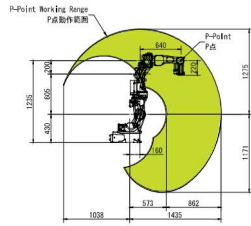

Reach	1435mm
Payload	4kg
Axes	7
Repeatability	± 0.08mm



### FD-V6S

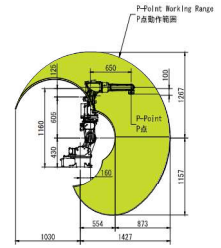

Reach	1427mm
Payload	6kg
Axes	7
Repeatability	± 0.08mm



### FD-B4LS

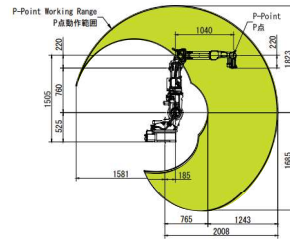

Reach	2008mm
Payload	4kg
Axes	7
Repeatability	± 0.08mm



### FD-V6LS

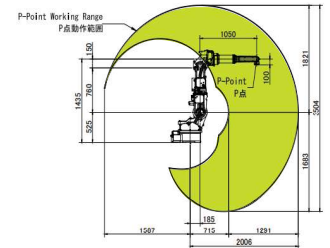

Reach	2006mm
Payload	6kg
Axes	7
Repeatability	± 0.08mm



### FD-V20S

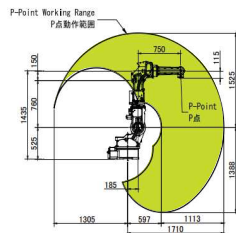

Reach	1710mm
Payload	20kg
Axes	7
Repeatability	± 0.08mm



### FD-V80

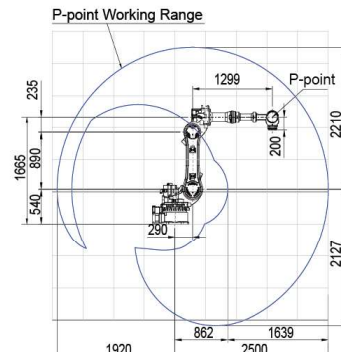

Reach	2500mm
Payload	80kg
Axes	6
Repeatability	± 0.08mm



### FD-V130

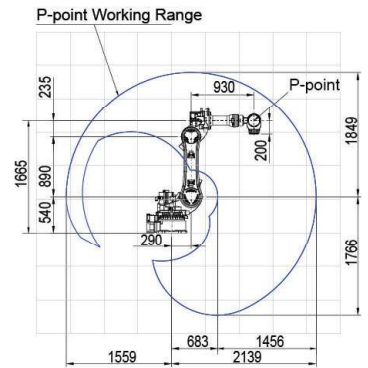

Reach	2139mm
Payload	130kg
Axes	6
Repeatability	± 0.08mm



### FD-V100

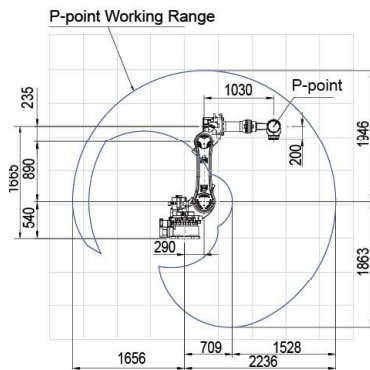

Reach	2236mm
Payload	100kg
Axes	6
Repeatability	± 0.08mm



### FD-A20

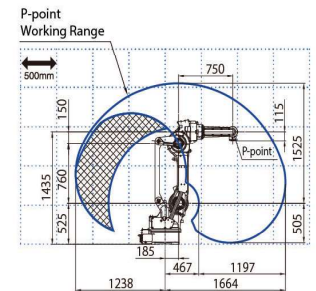

Reach	1664mm
Payload	20kg
Axes	6
Repeatability	± 0.07mm

# Specifications: Manipulator for 6 axis

			FD-B6	FD-B6L-S2	FD-V8
Model			NB6	NB6L	NV8
Number of axes			6	6	6
Maximum capacity			13.2 lbs (6kg)	13.2 lbs (6kg)	17.6 lbs (8kg)
Positional repeatability			±0.003" (±0.08mm) <sup>(1)</sup>	±0.002" (±0.05mm) <sup>(1)</sup>	±0.003" (±0.08mm) <sup>(1)</sup>
Horizontal Reach			56.88" (1445mm)	79.06" (2008mm)	55.29" (1402mm)
Vertical Reach			84.80" (2154mm)	138.75" (3575mm)	90.67" (2430mm)
Driving capacity			3132 W	4632 W	3016 W
Working Range	Arm	J1 (Rotation)	±170° (±50°) <sup>(2)</sup>	±170° (±50°) <sup>(2)</sup>	±170° (±50°) <sup>(2)</sup>
		J2 (Lower arm)	-155° to +90° <sup>(3)</sup>	-155° to +100°	-155° to +90° <sup>(3)</sup>
		J3 (Upper arm)	-170° to +245° <sup>(4)</sup>	-170° to +190°	-170° to +190°
	Wrist	J4 (Swing)	±155°(±170°) <sup>(5)</sup>	±155° (±170°) <sup>(5)</sup>	±180°
		J5 (Bending)	-45° to +225° <sup>(6)</sup>	-45° to +225° <sup>(6)</sup>	-50° to +230°
		J6 (Twist)	±205°(±360°) <sup>(5,6)</sup>	± 205° (±360°) <sup>(5,6)</sup>	±360°
Motion speed	Arm	J1 (Rotation)	4.19 rad/s {240°/s} (3.32 rad/s {190°/s}) <sup>(2)</sup>	3.93 rad/s{225°/s} (3.05 rad/s [175°/s]) <sup>(2)</sup>	4.19 rad/s {240°/s} (3.32 rad/s {190°/s}) <sup>(2)</sup>
		J2 (Lower arm)	4.19 rad/s {240°/s}	3.58 rad/s{205°/s}	4.19 rad/s {240°/s}
		J3 (Upper arm)	4.01 rad/s {230°/s}	3.84 rad/s{220°/s}	4.01 rad/s {230°/s}
	Wrist	J4 (Swing)	7.50 rad/s {430°/s}	7.50 rad/s {430°/s}	7.50 rad/s {430°/s}
		J5 (Bending)	7.50 rad/s {430°/s}	7.50 rad/s [430°/s]	7.50 rad/s {430°/s}
		J6 (Twist)	11.00 rad/s {630°/s}	11.00 rad/s {630°/s}	11.00 rad/s {630°/s}
Wrist allowable load	Allowable moment	J4 (Swing)	10.5 N•m	10.5 N•m	17.6 N•m
		J5 (Bending)	10.5 N•m	10.5 N•m	17.6 N•m
		J6 (Twist)	5.9 N•m	5.9 N•m	7.8 N•m
	Allowable moment of inertia	J4 (Swing)	0.28 kg•m <sup>2</sup>	0.28 kg•m <sup>2</sup>	0.43 kg•m <sup>2</sup>
		J5 (Bending)	0.28 kg•m <sup>2</sup>	0.28 kg•m <sup>2</sup>	0.43 kg•m <sup>2</sup>
		J6 (Twist)	0.06 kg•m <sup>2</sup>	0.06 kg•m <sup>2</sup>	0.09 kg•m <sup>2</sup>
Arm cross-sectional area			3.57 m <sup>2</sup> x 340°	6.37 m <sup>2</sup> x 340°	3.11 m <sup>2</sup> x 340°
Environmental conditions			32 to 113° F (0 to 45° C), 20 to 80% RH (no condensation)		
Mass / weight			320 lbs (145kg)	611 lbs (277kg)	613 lbs (278kg)
Maximum load of upper arm			22.05 lbs (10kg) <sup>(7)</sup>	44.09 lbs (20kg) <sup>(6)</sup>	44.09 lbs (20kg) <sup>(7)</sup>
Installation method			Floor/Ceiling/Wall		
Paint color			White (Munsell notation 10GY 9/1)		

## NOTES:

- (1) The value of the positional repeatability is at the tool center point (TCP) in compliance with ISO 9283.
- (2) The value in parentheses indicates wall mounted.
- (3) Working range of J2 axis may be restricted when wall mounted.
- (4) The operation range of the J3 axis is restricted to -170° to +205° when floor based welding is applied.
- (5) Working range of the J6 axis may be restricted by the position of the J5 axis.
- (6) When loading, the maximum payload as the end effector.
- (7) This value changes according to placement and load conditions of the wrist.



FD-V8L-S2	FD-H5	FD-V25-S2
NV8L	NH5	NV25
6	6	6
13.2 lbs (6kg)	11.02 lbs (5kg)	44.09 lbs (25kg)
±0.002" (±0.05mm) <sup>(1)</sup>	±0.002" (±0.05mm) <sup>(1)</sup>	±0.002" (±0.04mm) <sup>(1)</sup>
78.98" (2006mm)	34.09" (866mm)	67.32" (1710mm)
140.55" (3570mm)	54.1" (1374mm)	117.28" (2979mm)
4800 W	1440 W	5400 W
±170° (±50°) <sup>(2)</sup>	±170° (±50°) <sup>(2)</sup>	±170° (±50°) <sup>(2)</sup>
-155° to +100° <sup>(3)</sup>	-125° to +90°	-155° to +100° <sup>(3)</sup>
-170° to +260° <sup>(4)</sup>	-140° to +245°	-170° to +260° <sup>(4)</sup>
±180°	±190°	±180°
-50° to +230°	-30° to +210°	-50° to +230°
±360°	±360°	±360°
3.93 rad/s{225°/s} (3.05rad/s [175°/s]) <sup>(2)</sup>	3.49 rad/s {200°/s} (2.79 rad/s {160°/s}) <sup>(2)</sup>	3.93 rad/s{225°/s} (3.05rad/s {175°/s}) <sup>(2)</sup>
3.58 rad/s{205°/s}	3.49 rad/s {200°/s}	3.58 rad/s {205°/s}
4.45 rad/s{255°/s}	4.54 rad/s {260°/s}	4.45 rad/s {255°/s}
7.85 rad/s{450°/s}	6.63 rad/s {380°/s}	7.85 rad/s {450°/s}
7.50 rad/s (430°/s)	6.63 rad/s {380°/s}	7.68rad/s{440°/s}
11.00 rad/s (630°/s)	8.95 rad/s {510°/s}	10.60rad/s{605°/s}
17.6 N•m	11.9 N•m	2.6 N•m
17.6 N•m	11.9 N•m	52.6 N•m
7.8 N•m	5.21 N•m	24.5 N•m
0.43kg•m <sup>2</sup>	0.303kg•m <sup>2</sup>	1.24kg•m <sup>2</sup>
0.43kg•m <sup>2</sup>	0.303kg•m <sup>2</sup>	1.24kg•m <sup>2</sup>
0.09kg•m <sup>2</sup>	0.061kg•m <sup>2</sup>	0.33kg•m <sup>2</sup>
7.48 m <sup>2</sup> x 340°	1.22 m <sup>2</sup> x 340°	5.27 m <sup>2</sup> x 340°
602 lbs (273kg)	128 lbs (58kg)	613 lbs (278kg)
44.09 lbs (20kg) <sup>(5)</sup>	2.21 lbs (1kg) <sup>(6)</sup>	22.05 lbs (10kg) <sup>(5)</sup>

- Through-arm cable design improves torch reach & wire feeding
- Offers a wide working range with an independently articulated arm
- Seamless digital connection with all OTC DAIHEN brand welding power supplies
- Improved vibration restraining control provides smooth robot movement
- Built-in mechanical shock sensor
- Single source technology – all components are manufactured by OTC DAIHEN
- Highly versatile design supports most welding applications

# Specifications: Manipulator for 7-axis

			FD-B4S	FD-B4LS	FD-V6S	FD-V6LS
Model			NB4S	NB4LS	NV6S	NV6LS
Number of axes			7	7	7	7
Maximum capacity			8.8 lbs (4kg)	8.8 lbs (4kg)	13.23 lbs (6kg)	13.23 lbs (6kg)
Positional repeability			±0.003" (±0.08mm) <sup>(1)</sup>	±0.003" (±0.08mm) <sup>(1)</sup>	±0.003" (±0.08mm) <sup>(1)</sup>	±0.003" (±0.08mm) <sup>(1)</sup>
Horizontal Reach			56.50" (1435mm)	79.06" (2008mm)	55.29" (1427mm)	78.98" (2006mm)
Vertical Reach			96.30" (2446mm)	138.75" (3508mm)	90.67" (2424mm)	137.95" (3504mm)
Driving capacity			3550W	5650W	3600W	6000W
Working Range	Arm	J1 (Rotation 1)	±170°	±170°	±170°	±170°
		J2 (Lower arm)	-145° to +70°	-145° to +70°	-145° to +70°	-145° to +70°
		J7(Rotation 2)	±90°	±90°	±90°	±90°
	Wrist	J3 (Upper arm)	-170° to +142.6°	-170°~ +154°	-170°~ +149°	-170° to +160°
		J4 (Swing)	±155°	±155°	+/- 180°	±180°
		J5 (Bending)	-45° to +225° <sup>(2)</sup>	-45° to +225° <sup>(5)</sup>	-50°~ +230° <sup>(2)</sup>	-50° to +230° <sup>(2)</sup>
		J6 (Twist)	±205° <sup>(2)</sup>	±205° <sup>(2)</sup>	+/- 360° <sup>(2)</sup>	±360° <sup>(2)</sup>
Motion speed	Arm	J1 (Rotation 1)	3.66 rad/s (210°/s)	3.40 rad/s (195°/s)	3.66 rad/s (210°/s)	3.40 rad/s (195°/s)
		J2 (Lower arm)	3.66 rad/s (210°/s)	3.49 rad/s (200°/s)	3.66 rad/s (210°/s)	3.49 rad/s (200°/s)
		J7(Rotation 2)	3.14rad/s (180°/s)	2.79rad/s (160°/s)	3.14rad/s (180°/s)	2.79rad/s (160°/s)
	Wrist	J3 (Upper arm)	3.66 rad/s (210°/s)	3.49 rad/s (200°/s)	3.66 rad/s (210°/s)	3.49 rad/s (200°/s)
		J4 (Swing)	7.33 rad/s (420°/s)	7.33 rad/s (420°/s)	7.33 rad/s (420°/s)	7.33 rad/s (420°/s)
		J5 (Bending)	7.33 rad/s (420°/s)	7.33 rad/s (420°/s)	7.33 rad/s (420°/s)	7.33 rad/s (420°/s)
		J6 (Twist)	10.5 rad/s (600°/s)	10.5 rad/s (600°/s)	10.82 rad/s (620°/s)	10.82 rad/s (620°/s)
Wrist allowable load	Allowable moment	J4 (Swing)	10.1 N*m	10.1 N*m	11.8 N*m	11.8 N*m
		J5 (Bending)	10.1 N*m	10.1 N*m	9.8 N*m	9.8 N*m
		J6 (Twist)	2.94 N*m	2.94 N*m	5.9 N*m	5.9 N*m
	Allowable moment of inertia	J4 (Swing)	0.38kg*m <sup>2</sup>	0.38kg*m <sup>2</sup>	0.30kg*m <sup>2</sup>	0.30kg*m <sup>2</sup>
		J5 (Bending)	0.38kg*m <sup>2</sup>	0.38kg*m <sup>2</sup>	0.25kg*m <sup>2</sup>	0.25kg*m <sup>2</sup>
		J6 (Twist)	0.03kg*m <sup>2</sup>	0.03kg*m <sup>2</sup>	0.06kg*m <sup>2</sup>	0.06kg*m <sup>2</sup>
Arm cross-sectional area			2.57 m <sup>2</sup> x 340°	5.28 m <sup>2</sup> x 340°	5.28 m <sup>2</sup> x 340°	5.40 m <sup>2</sup> x 340°
Environmental conditions			32 to 113° F (0 to 45° C), 20 to 80% RH (no condensation)			
Mass / weight			416.67 lbs (189kg)	707.68 lb (321kg)	392.42lb(178 kg)	696.67lbs (316kg)v
Maximum load of upper arm			22.05 lbs (10kg) <sup>(3)</sup>	22.05 lbs (10kg) <sup>(3)</sup>	22.05 lbs (10kg) <sup>(3)</sup>	44.09 lbs (20kg) <sup>(3)</sup>
Installation method			Floor			
Paint color			White (Munsell notation 10GY 9/1)			

## NOTES:

- (1) The value of the positional repeatability is at the tool center point (TCP) in compliance with ISO 9283.
- (3) Working range of J2 axis may be restricted when wall mounted.
- (4) The operation range of the J3 axis is restricted to -170° to +205° when floor based welding is applied.
- (5) Working range of the J6 axis may be restricted by the position of the J5 axis.
- (6) When loading, the maximum payload as the end effector.
- (7) This value changes according to placement and load conditions of the wrist.

## FD-V20S

NV20S

7

44.09lbs (20kg)

$\pm 0.003''$  ( $\pm 0.08\text{mm}$ )<sup>(1)</sup>

67.32" (1710mm)

114.69" (2913mm)

6600W

$\pm 170^\circ$

$-145^\circ$  to  $+70^\circ$

$\pm 90^\circ$

$-1710^\circ$  to  $+160^\circ$

$\pm 180^\circ$

$-50^\circ$  to  $+230^\circ$  <sup>(2)</sup>

$\pm 360^\circ$  <sup>(2)</sup>

3.40 rad/s (195°/s)

3.32 rad/s (190°/s)

3.14 rad/s (180°/s)

6.98 rad/s (400°/s)

6.98 rad/s (400°/s)

10.5 rad/s {600°/s}

43.7N\*m

43.7N\*m

19.6 N\*m

1.09 kg\*m<sup>2</sup>

1.09 kg\*m<sup>2</sup>

0.24kg\*m<sup>2</sup>

3.91m<sup>2</sup> x 340°

707.69lbs (321kg)

44.09lbs (20kg)<sup>(3)</sup>

# ULTRA-FLEX Series

The ULTRA-FLEX SERIES arc welding robots are OTC DAIHEN's solution to avoid interference with the work and tooling without changing the position and/or attitude of the robot. Access to a proper welding position is possible without a positioner. The result is savings in space and costs compared to a conventional 6-axis system.

Five models available. A perfect robot for every application.

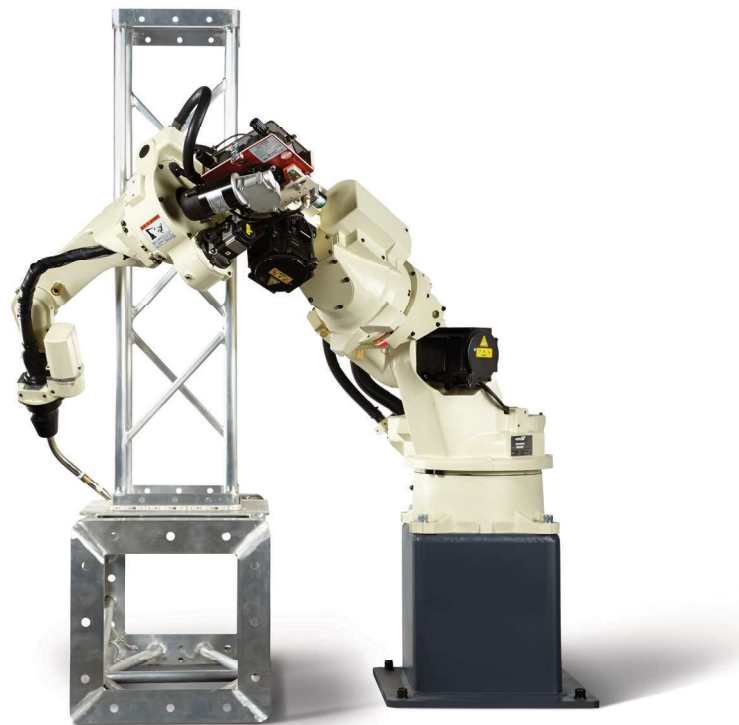

# Specifications: Manipulator for FD-V100 SERIES

		FD-V80	FD-V100	FD-V130
Model		NV80	NV100	NV130
Number of axes		6	6	6
Maximum capacity		176.37 lbs (80 kg)	220.46 lbs (100 kg)	286.60 lbs (130 kg)
Positional repeatability		±0.003" (±0.08mm)		
Horizontal Reach		2500 mm	2236 mm	2139 mm
Vertical Reach		4337 mm	3809 mm	3615 mm
Driving capacity		15100W		
Working Range	Arm	J1 (Rotation)	±180°	
		J2 (Lower arm)	-155° to +90°	
		J3 (Upper arm)	-185° to +220°	
	Wrist	J4 (Swing)	±360°	
		J5 (Bending)	-35° to +215°	
		J6 (Twist)	±360°	
Motion speed	Arm	J1 (Rotation)	2.44 rad/s (140°/s)	
		J2 (Lower arm)	1.92 rad/s (110°/s)	
		J3 (Upper arm)	2.44 rad/s (140°/s)	
	Wrist	J4 (Swing)	3.05 rad/s (175°/s)	
		J5 (Bending)	3.05 rad/s (175°/s)	
		J6 (Twist)	4.45 rad/s (255°/s)	
Wrist allowable load	Allowable moment	J4 (Swing)	433.0 N•m	721.0 N•m
		J5 (Bending)	433.0 N•m	721.0 N•m
		J6 (Twist)	294.0 N•m	
	Allowable moment of inertia	J4 (Swing)	31.4 kg•m <sup>2</sup>	60.0 kg•m <sup>2</sup>
		J5 (Bending)	31.4 kg•m <sup>2</sup>	60.0 kg•m <sup>2</sup>
		J6 (Twist)	11.9 kg•m <sup>2</sup>	33.7 kg•m <sup>2</sup>
Arm cross-sectional area		9.53 m <sup>2</sup> x 360°	7.56 m <sup>2</sup> x 360°	6.83 m <sup>2</sup> x 360°
Environmental conditions		32 to 113° F (0 to 45° C), 20 to 80% RH (no condensation)		
Mass / weight		780 kg	770kg	765 kg
Maximum load of upper arm		50 kg <sup>(2)</sup>		
Installation method		Floor/Ceiling		
Paint color		White (Munsell notation 10GY 9/1)		

- Optimized for the speed, lifting capacity
- Slim wrist and upper arm
- Small mounting footprint
- DeviceNet
- Discrete I/O
- Pneumatic lines
- User application cable conduit (Robot base-to-shoulder routing included)

## NOTES:

(1) The value of the positional repeatability is at the tool center point (TCP) in compliance with ISO 9283.

# Specifications: Manipulator FD-A20

			FD-A20
Model			NA20
Number of axes			6
Maximum capacity			44.09 lbs (20kg)
Positional repeatability			±0.003" (±0.07mm) <sup>(1)</sup>
Horizontal Reach			1664mm
Vertical Reach			2030mm
Driving capacity			7900W
Working Range	Arm	J1 (Rotation)	±170°
		J2 (Lower arm)	-70° to +60°
		J3 (Upper arm)	-140° to +240° <sup>(2)</sup>
	Wrist	J4 (Swing)	±180°
		J5 (Bending)	-50° to +230°
		J6 (Twist)	±360°
Motion speed	Arm	J1 (Rotation)	3.40 rad/s(195°/s)
		J2 (Lower arm)	3.32 rad/s(190°/s)
		J3 (Upper arm)	3.14 rad/s(180°/s)
	Wrist	J4 (Swing)	6.98 rad/s(400°/s)
		J5 (Bending)	6.98 rad/s(400°/s)
		J6 (Twist)	10.5 rad/s(600°/s)
Wrist allowable load	Allowable moment	J4 (Swing)	43.7N•m
		J5 (Bending)	43.7N•m
		J6 (Twist)	19.6N•m
	Allowable moment of inertia	J4 (Swing)	1.09kg•m <sup>2</sup>
		J5 (Bending)	1.09kg•m <sup>2</sup>
		J6 (Twist)	0.24kg•m <sup>2</sup>
Arm cross-sectional area			3.32m <sup>2</sup> ×340°
Environmental conditions			32 to 113° F (0 to 45° C), 20 to 80% RH (no condensation)
Mass / weight			783 lbs (355kg)
Maximum load of upper arm			44.09 lbs (20kg) <sup>(3)</sup>
Installation method			Floor/Ceiling
Paint color			White(Munsell 10GY9/1)

- High tracking accuracy throughout the entire robot work envelope.
- High accuracy delivered in both straight-line and small-arc applications.
- The best choice for laser welding and cutting, TIG, and other tasks requiring high accuracy.

## Notes

1. Positional repeatability of the tool center point (TCP) value complies with the JIS-B-8432 Standard.
2. The working range of the J3 axis is restricted to -140 degrees to +165 degrees when floor-based welding is applied.
3. The capacity of the upper arm varies with the wrist capacity.

# Complete lineup of industrial robots to meet all of your factory floor applications!

## Small and Light Payload Robots

## Medium Payload Robots

	Small and Light Payload Robots	Medium Payload Robots				
Model	H5	B6	B6L	V8	V8L	V25
Max. Reach	866	1445	2008	1437	2006	1710
Payload	5	6	6	8	8	25

**DAIHEN leverages our robot technology across the manufacturing facility to produce DAIHEN industrial robots**

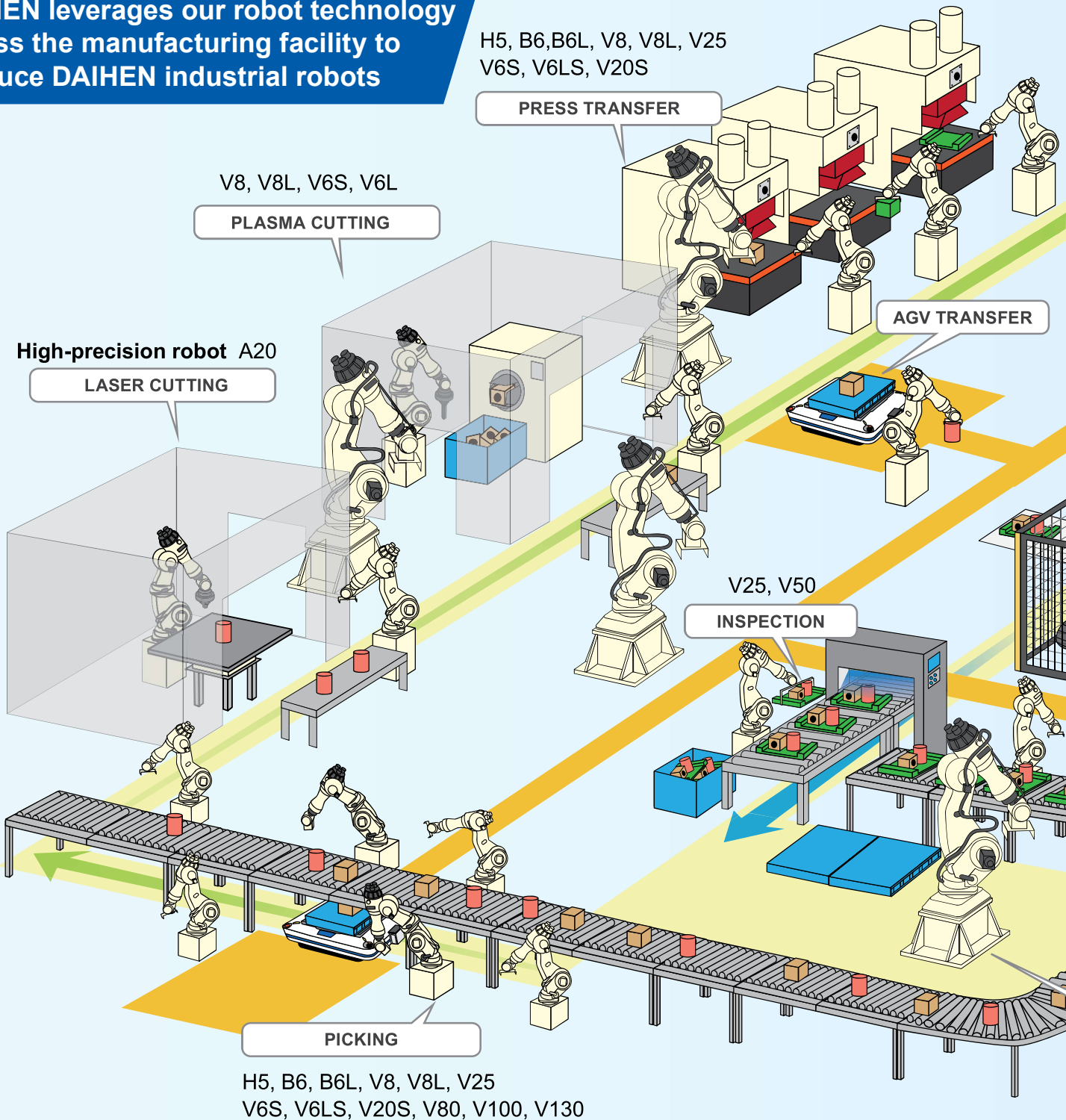

H5, B6, B6L, V8, V8L, V25  
V6S, V6LS, V20S

PRESS TRANSFER

V8, V8L, V6S, V6L  
PLASMA CUTTING

High-precision robot A20  
LASER CUTTING





AGV TRANSFER

V25, V50  
INSPECTION

PICKING

H5, B6, B6L, V8, V8L, V25  
V6S, V6LS, V20S, V80, V100, V130



7-Axis Robots

				
<b>B4S</b>	<b>B4LS</b>	<b>V6S</b>	<b>V6LS</b>	<b>V20S</b>
1435	2008	1427	2006	1710
4	4	6	6	20

High Accuracy Robot

<b>A20</b>
1664
20

High Payload Robots

		
<b>V80</b>	<b>V100</b>	<b>V130</b>
9430	9430	9430
80	100	130

(mm)  
(kg)

V6S, V6LS, V20S

MACHINE TOOL TENDING

WELDING

H5, B6, B6L,  
V8, V8L, V25, A20,  
B4S, B4LS, V6S, V6LS, V20S

Guideless Autonomous Carriage  
AiTran

POLISHING

SCREW SORTING

ASSEMBLY & SCREWDRIVING

V6S, V6LS, V20S, V80,  
V100, V130, V8, V25

DEBURRING

V25

HANDLING

V80, V100, V130

Automobile manufacturing process

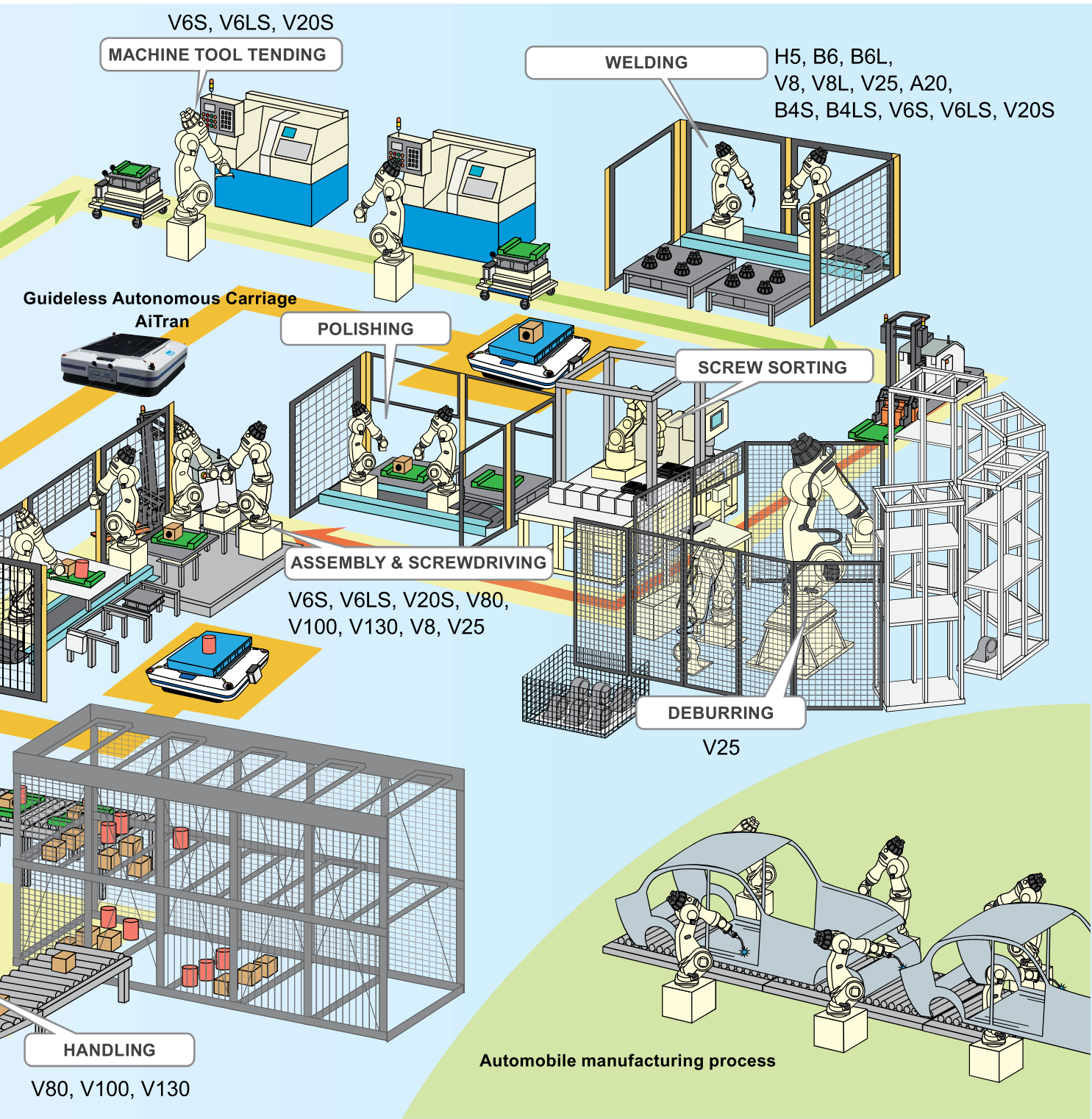

# SINGLE SOURCE ADVANTAGE

Our single source approach is simple: we provide all the equipment needed for robotic or manual arc welding. One call solves it all!

- Seamless digital integration for maximum control
- Reduced maintenance time for greater uptime and productivity
- Expert service from experienced support staff



**ROBOT,  
WELDING POWER SOURCE,  
WIRE FEEDER,  
TORCH.  
WE PROVIDE IT ALL.**

## SEAMLESS SOLUTIONS

Our cells can provide arc welding solutions for a range of parts from small to large size, with minimal operator movement required and little to no part positioning. The compact designs reduce required manufacturing floor space. All cells include an arc welding robot, a robot controller, a teach pendant and a positioner.

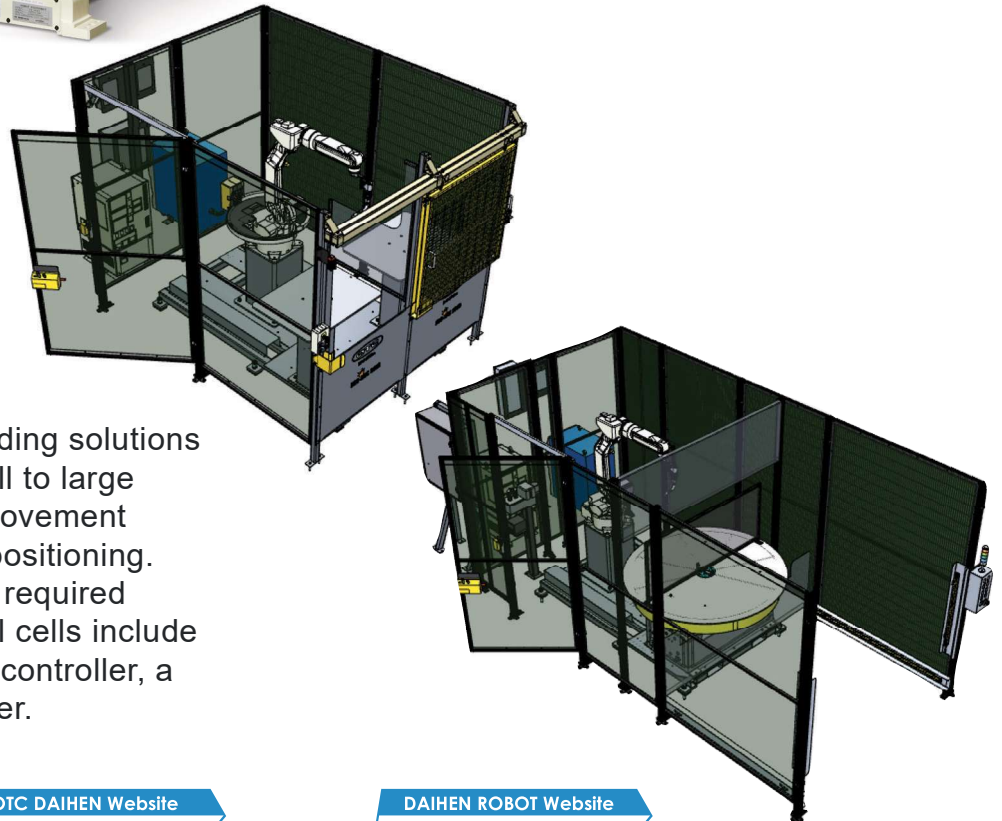

OTC DAIHEN Website  
[www.DAIHEN-USA.com](http://www.DAIHEN-USA.com)

DAIHEN ROBOT Website  
[www.DAIHEN-robot.com/en](http://www.DAIHEN-robot.com/en)



### NORTH AMERICA CORPORATE HEADQUARTERS

1400 Blausler Dr, Tipp City OH 45371  
Phone: (937) 667-0800  
Fax: (937) 667-0885

### ATLANTA TECHNICAL CENTER

3135 Medlock Bridge Road  
Norcross, GA 30071  
Phone: 888-OTC-ROBO  
Fax: (937) 667-0885

### DETROIT TECHNICAL CENTER

750 Welch Road  
Commerce Township, MI 48390  
Phone: 888-OTC-ROBO  
Fax: (937) 667-0885



Member of DAIHEN Group

OTC-5 REV010/21